

NOVA CORE

USER MANUAL

Premium Whole House Ultrafiltration System





CONTENTS

1. Structure Diagram	01
2. Function & Feature	01
3. Product Parameters	03
4. Life Service For Filter Cartridge	03
5. Electrical Diagram	04
6. Water Production Principle	04
7. UF Membrane Flush Principle	05
8. Installation Notice	06
9. Installation Steps	06
10. First Use	10
11. Daily Use	10
12. Key Function Description	11
13. State Display	12
14. Parameter Setting	15



15. Working Mode	18
16. The Usage of the Sensor Probe	18
17. Daily Flushing	20
18. Usage Notice	21
19. Storage Notice	22
20. Filter Element Replacement	22
21. Method of Replacement	23
22. Electric Valve Maintenance or Replacement	25
23. The Battery Replacement	25
24. Key Function Description	27
25. Packing List	28
26. Ultrafiltration Membrane Technology	28
27. Filtration Principle of Ultrafiltration Membrane	29



STRUCTURE DIAGRAM

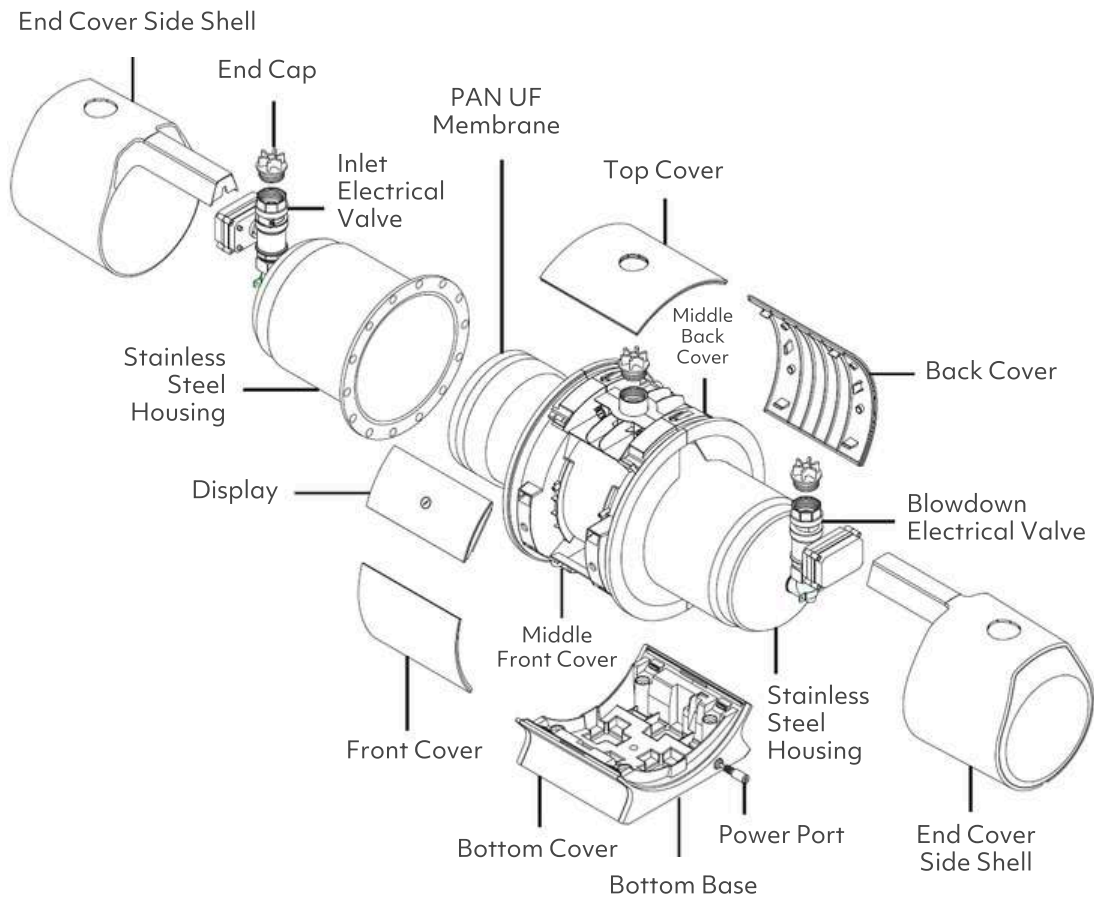

FUNCTION & FEATURE

Clean and Healthy

High precision ultra filtration membrane screening and filtration technology, filtration accuracy up to 0.01 micron; Removal of sediment, rust, colloid and pathogenic bacteria are in line with the relevant national standards, while retaining beneficial minerals and trace elements in the water.

Long Service Life

Long service life of filter cartridge, modified PAN membrane formula, hydrophilic, strong pollution resistance; Mirror film making process, high surface finish, stain resistance and easy to wash; Frequent washing, timely exclusion of trapped pollutants, prolong the service life.



Super Large Water Flow

Adequate design of water purification flow, fully meet the needs of the whole house water villa large duplex family. 304 stainless steel housing grinding process, water hammer dynamic pressure, static pressure, blasting test higher than the industry standard.

Easier Installation

Exquisite horizontal support, easily put the water purifier on the horizontal place, also wall hanging installation.

Leakage Detection

Water volume and time for double detection to ensure safety.

Remote Wireless Control

It can be remote controlled the valve open and closed, control range 10-30 meters. The main device can be paired with 1 remote control and 7 pieces sensor probe, can quickly and accurately sense the sensor and close the valve.

Double Power Supply

Built-in lithium battery, double power automatic switch, automatic charge and discharge protection function, power outage also leak proof.

Smart Controlling System

WiFi smart controlling, remote control via mobile APP, can be easily controlled without on-site operation.



PRODUCT PARAMETERS

Product Name		Nova Core	
Item No.	IMT-U8	Inlet Pressure	0.1-0.4MPa
Filter Type	Ultra Filtration Membrane	Temperature	5°C-38°C
Application	Municipal Tap Water	Product Size	806*290*316(mm)
Filtration Accuracy	0.01μm	Flow Rate	4m ³ /h
Rated Power	2W	Anti Electric Shock Type	III Class

LIFE SERVICE FOR FILTER CARTRIDGE

With the long-term use of the water purification system, the water flow will gradually decline, please replace the filter cartridge regularly in order to ensure the water flow reaching the standard.

Type	Filtration accuracy	Material	Suggest To Replace (Months)	Qty (pcs)	Parts diagram
Ultra Filtration Membrane	0.01μm	PAN	12 Months	1pc	



ELECTRICAL DIAGRAM

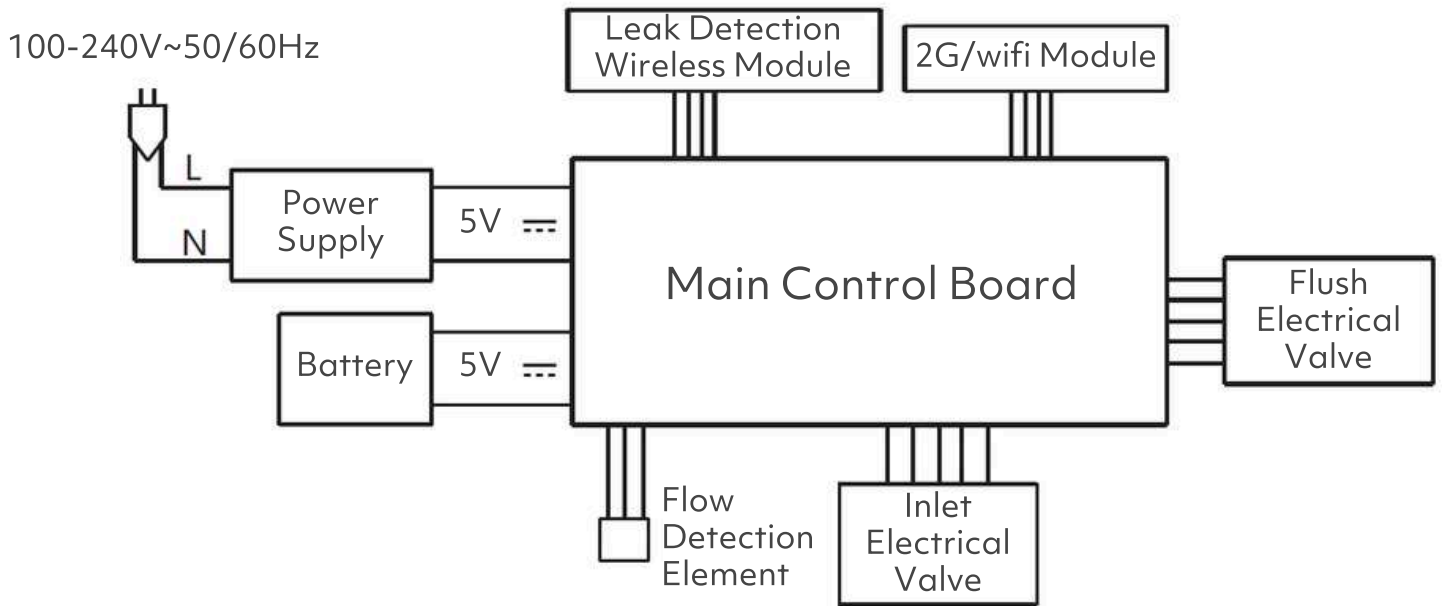

WATER PRODUCTION PRINCIPLE

Turn off the sewage port when in water production, as pic.2 shows: the source water (tap water) flows via inlet, then flows through ultra filtration membrane to intercept the sands, rust, colloid, pathogenic bacteria, etc. Also retaining the original minerals and trace elements in the water at the same time, and the purified water comes out from the outlet.

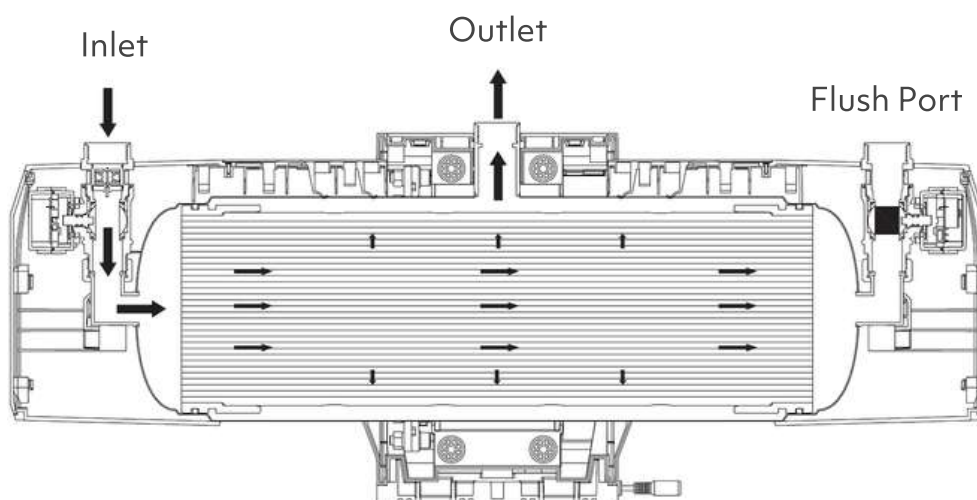



UF MEMBRANE FLUSH PRINCIPLE

During the use of the water purification system, the pollutants left by the adsorption and load of the membrane are collected in the water purification system (attached to the inner surface of the ultra-membrane), if not discharged in time, will be easy to make the water purification system become a secondary pollution. At the same time, the water production of the water purification system is continuously decreased due to the contamination attached to the surface of the ultra filtration membrane and blocked the micro pores of the ultra filtration membrane, so that the water purification system should be flushed during the period to extend the service life of the water purification system.

Flush Principle

When the flush valve is turned on, outlet is turned off, the system is under the flushing state; The tap water flows in through the water inlet, and the water directly rushes through the ultra filtration membrane to the sewage outlet, flushing off the pollutants attached to the wall of the ultra filtration membrane and discharging away through the sewage outlet.

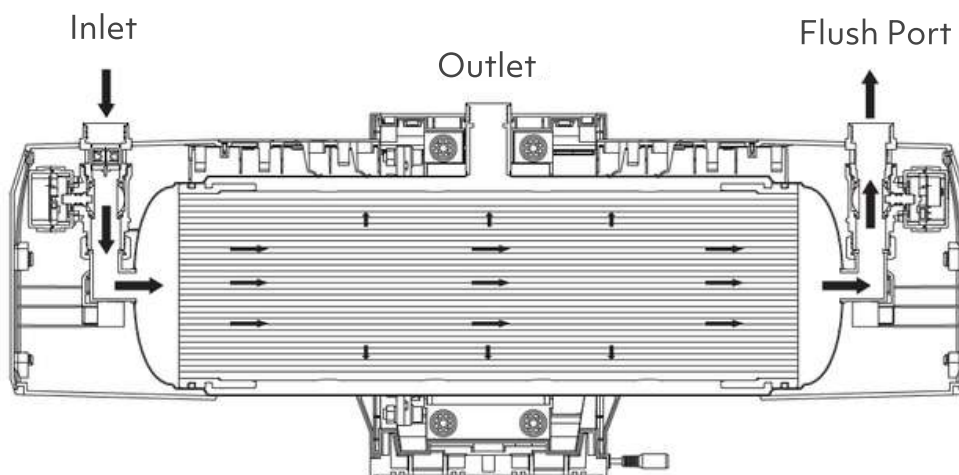

Backwash Principle

Turn off the inlet valve, turn on the flush valve, the tap water flows into the outlet, the system is under backwashing state; The raw water flows through the channel between the outer wall of the ultrafiltration membrane and the inner wall of the stainless steel housing, enters the outer side of the ultrafiltration membrane, and penetrates into the interior of the ultrafiltration membrane under the action of water pressure. The dirt attached to the micropore wall of the ultrafiltration membrane is rinsed off, and finally the dirt is discharged from the flushing port. (as shown in the picture below)

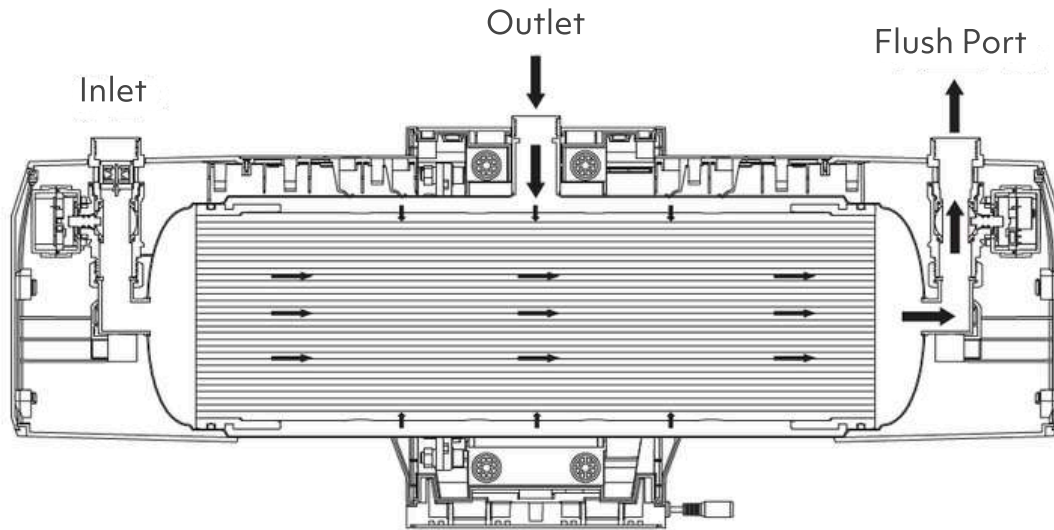

INSTALLATION NOTICE

1. In order to make the water purification system meet the requirements of water quality and demand, the water quality, inlet pressure, inlet flow and inlet temperature of the water purification system should meet the requirements of parameters in the table.
2. All the pipes, joints, faucets and other water-related accessories of the water purification system should meet the national health standards.
3. Do not install in the outdoor, to prevent freezing crack; At the same time, direct sunlight should be prevented to prevent the housing from aging too quickly; If it is installed outdoors, corresponding protective devices must be added.

INSTALLATION STEPS

1. Checking The Inlet Water Pressure

Install a inlet valve on the inlet pipeline, use the pressure testing device to check the water pressure whether it between 0.1-0.4Mpa or not, as shown in the pic below.

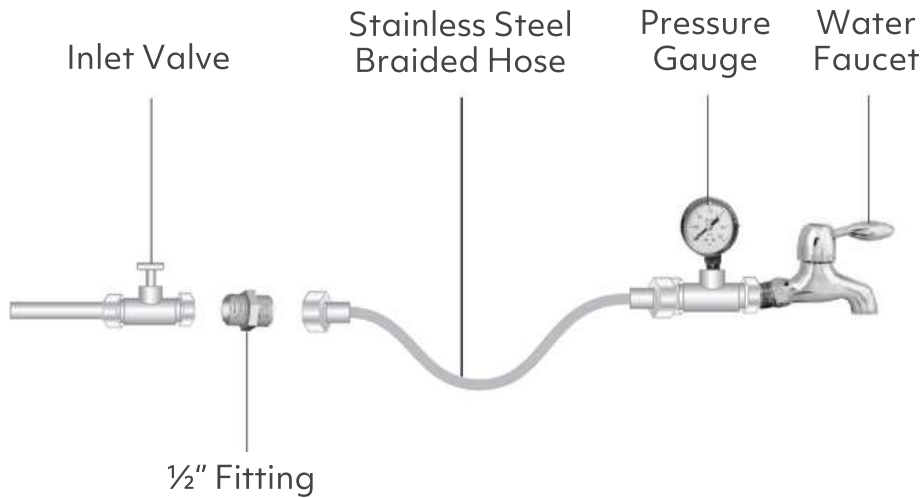

2. Installation For Fittings and Pipeline

Under Sink Installation

In general (most cases), the main entrance into the kitchen after the 4 branch, because the cabinet space is limited, suitable for braided hose or bellow connected to the water purification system.

- Take down the end cap of water inlet, water outlet and flush port of water purification system;
- Connect the braided hose with inlet valve, and connect the outlet with the purification pipeline, flush port connect with the flush pipeline.

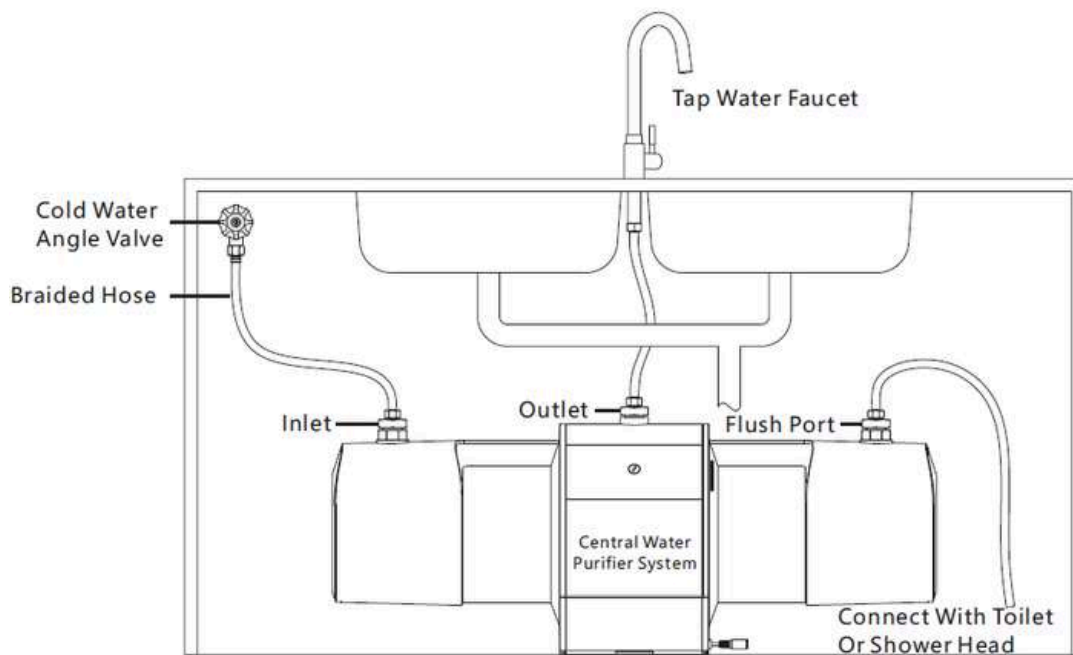

The Braided Hose Connection Diagram



Installation Of Other Positions

Generally speaking, the installation position of water purification system can be arranged in the other position of household water mains (such as toilet, balcony, pipeline well), and the size of main pipe is 1 inch or 3/4" tubing below the case, most of the PPR tubing or PE tubing flame connection method for pipeline and joint connection.

- a. Take down the end cap of inlet, outlet and flush port of water purification system.
- b. Install a fitting to connect the pipeline with the water purification system, as shown in pic. Install a by pass line between the inlet valve and outlet valve, and install by pass valve.

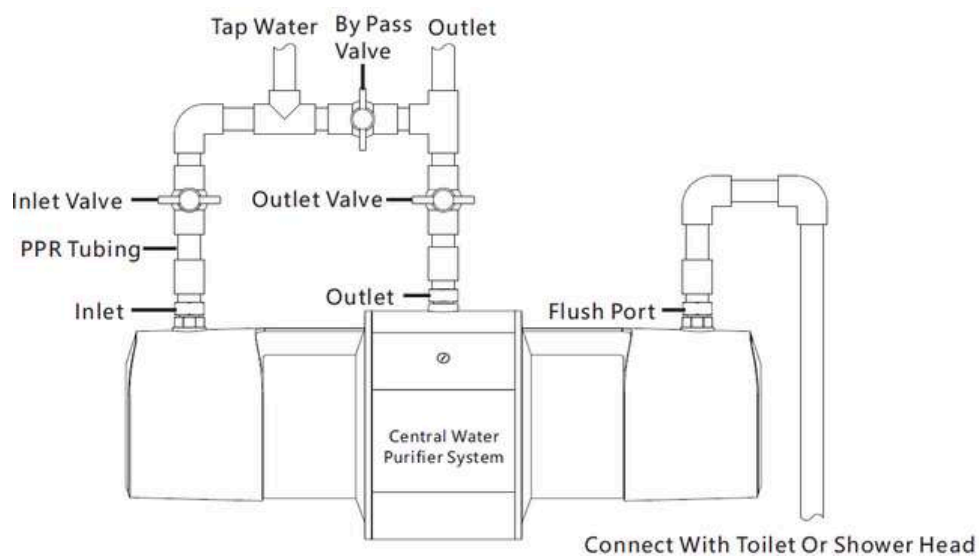

Ppr Tubing Connection Diagram

3. Fixed Water Purification System

- a. If it is installed on the ground, there is no need to fix it, just place the it flat on the ground.
- b. If wall-hanging installation is required, align the mounting board to the appropriate installation position first, and then drill holes in the mounting holes on the board (one side of the mounting board shall be mounted horizontally and the other side shall be mounted vertically). After drilling the hole, take away the cardboard, drive into the expansion pin, fix the installation pendant randomly with self-tapping screws on the wall, then hold up the water purification system with both hands, insert the bracket of the water purification system support into the installation pendant and clamp it tightly.
- c. When choosing wall-mounted installation, the base of the water purification system can be switched to wall-mounted installation position, which ensures that the direction of the waterway is unchanged and the pipeline connection is more convenient. (as shown in the picture below).

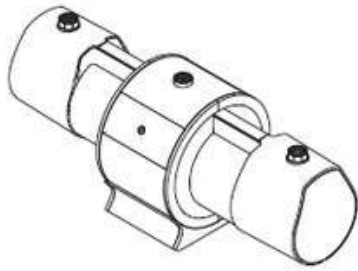

Vertical Bottom Base

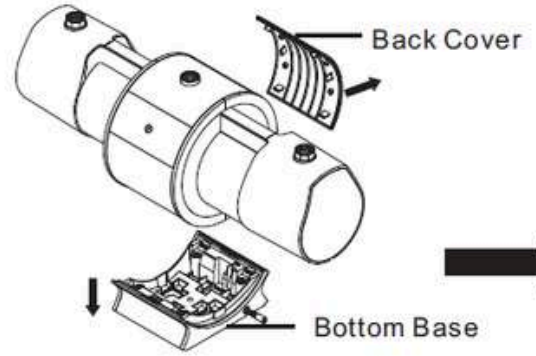

Disassemble The Base And Back Cover

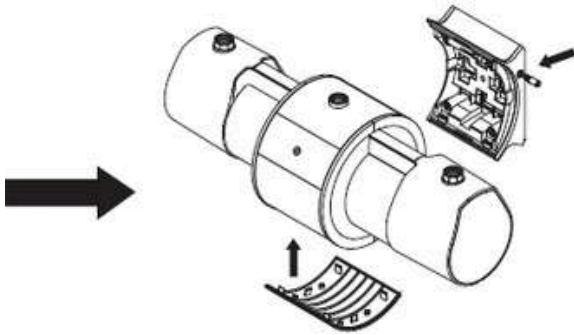

Install The

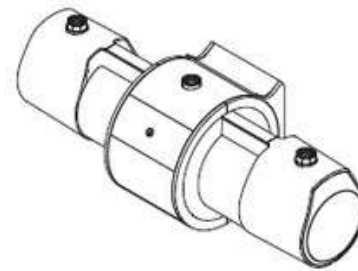

Hanging Base

Cross Hanging Cardboard

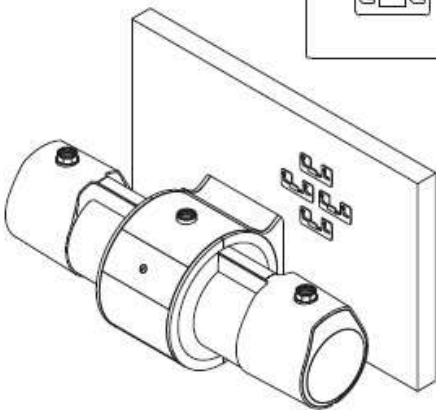
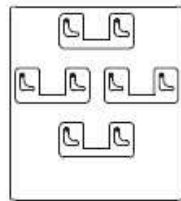

Cross Hanging Diagram

Vertical Cardboard

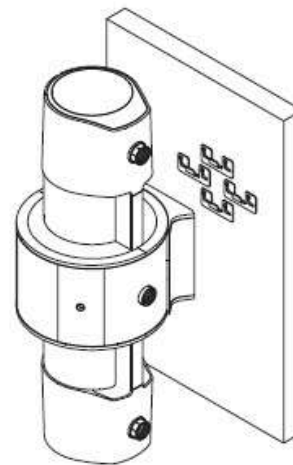
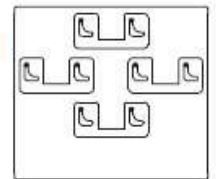

Vertical Hanging Diagram

4. Leakage Checking

After installation, check each joint carefully for whether there is water leakage.



FIRST USE

Please flush the central water purification system when first use to flush the protective liquid of the membrane.

1. Connect the power supply and turn off the outlet valve, long press “⌚” for 3 seconds to activated the LED screen, then long press “SET” for 3 seconds to start manual flush for more than 30 times continuous.
2. Turn on the purified water faucet for water production 20 minutes and discharge it.
3. Turn off the purified water faucet and keep it quiescent for 12 hours.
4. After 12 hours later, turn on the purified water faucet for water production 20 minutes to discharge it ,and repeat this more than 4 cycles before normal use.

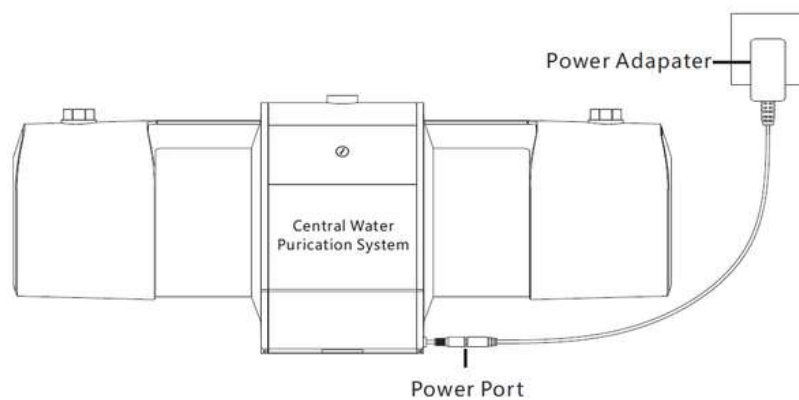

DAILY USE





Operation Panel & Button





KEY FUNCTION DESCRIPTION

Listed as flowing:

Key	Short Press	Long Press	Continuous Press	Combination Key
 MENU	Short press to select parameter in the parameter setting mode.	Long press 3 seconds to enter into the parameter setting or save the setting.	Continuous press 5 times to enter in the pairing mode for leak sensor probe and remote controller.	Press the "MENU"+ "SET" at the same time for 3 seconds to release E1,E2 alarm.
 SET	It is the transposition key in parameter setting when short press it.	<ol style="list-style-type: none"> In the process of automatic flushing, press again to stop flushing and enter water production. When the flushing time is set to 0, long press for 3 seconds to open and close the flush electric valve. 	Continuous press 3 times to open or close the inlet electric valve	<p>Press the "SET"+ "RESET" at the same time for 3 seconds to restore factory setting.</p> <p>Press the "MENU"+ "RESET" at the same time for 3 seconds to enter into WIFI pairing mode.</p> <p>Press the "MENU"+ "SET" + "RESET" at the same time for 3 seconds to open or close the inlet valve manually.</p>
 RESET	Short press "RESET" to adjust the numbers in parameter setting.	<ol style="list-style-type: none"> Long press 3 seconds to reset the filter service life which is expired. Long press 10 seconds to reset the filter service life. 		Press the "⌚" + "RESET" at the same time for 3 seconds for fully screen display.
	Long press 3 seconds to turn on or off.			



NOTE: "E1" : indicates that the valve closing failure, "E2" : indicates that the valve opening failure.



STATE DISPLAY

All data displayed on the following page is used as an example.

1. Power on and long press “⌚” 3 seconds to turn on the machine and will be BEEP sounds and LED screen shows current time, and it will turn off after 15 seconds, and the system will self-check at the same time.
2. Normal display: The LED screen shows the current time 12(H):00(min) when there is no water using, As shown in following picture.



3. When water production, the flowmeter rotates. At this time, the water production is in normal state: the LED screen displays the countdown of single time water consumption volume and the countdown of single water consumption time (switching two displays every 8 seconds), and the water production indicator is on.

“VOLUME” + “L” indicator light up at the same time, LED screen shows the remaining water consumption decline(L), 180-179-...0 decrease.

“WATER TIME” + “min” indicator light up at the same time, LED screen shows the continuous water shut-off valve time(min), 45-44-...0 countdown. As shown in following picture.



4. Flushing mode: the flushing indicator keeps on, LED screen displays the countdown of flushing time(auto flushing and manual flushing displays the same). As shown in following picture.





5. Service mode:

- a. Normal working mode: LED backlight keeps on, the “✕” character flashes (frequency is 1 Hz), and the buzzer "BEE,BEE,...", The frequency is 1 second (1Hz) and the alarm goes on.
- b. Power saving working mode: LED backlight keeps on, “✕”(frequency is 1 Hz), and the buzzer "BEE" for 20 times, the frequency is 1 second (1Hz) and then stop alarming, the backlight keeps off, but the screen still shows in alert state.
- c. The service mode for electric valve U1 and and U2 is different. U1 electric valve: E1 represents electric valve close failure. E2 represents electric valve open failure. As shown in following picture.

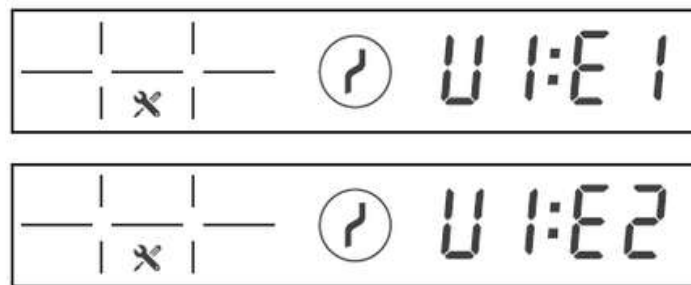

U2 electric valve: E1 represents electric valve close failure. E2 represents electric valve open failure. As shown in following picture.

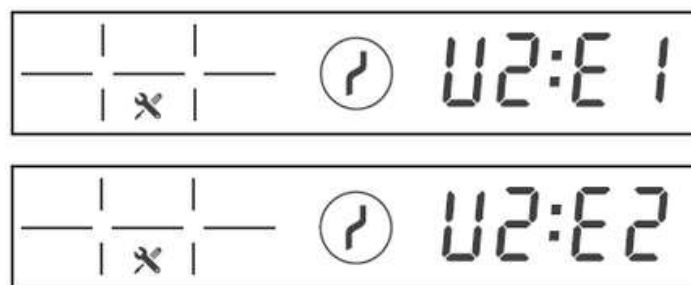

6. Low battery alarm display: When the battery voltage reach to 3.3 V ,it will come into low battery alarm. “🔋” quick flashes, the buzzer Beep 10 times, and it will repeat again every 60 minutes (after beeps 10 times, the LED screen keeps off, but the machine is still in alarming mode, just the screen is off and buzzer is not beeps.). Until connect the external power supply,it will stop alarming; When the battery voltage reach to 3.0V, it will auto shut-off valve and power off, as shown in the below pictures.







7. Leak alarm display:





- Normal working mode: LED screen lights up, the buzzer alarms till open the valve manually.
- Power saving mode: LED screen lights up and alarms for 20 seconds, then it will auto shut off valve; After alarms 20 seconds, the LED screen stays off but the machine still in alarming status, and will not repeat alarming till valve opened manually.

***VOLUME (single time water use consumption volume) alarm: "V"+" " indicator quick flashes, "L" indicator lights up, buzzer alarm, valve closed, LED screen shows OFF, as shown in below picture.

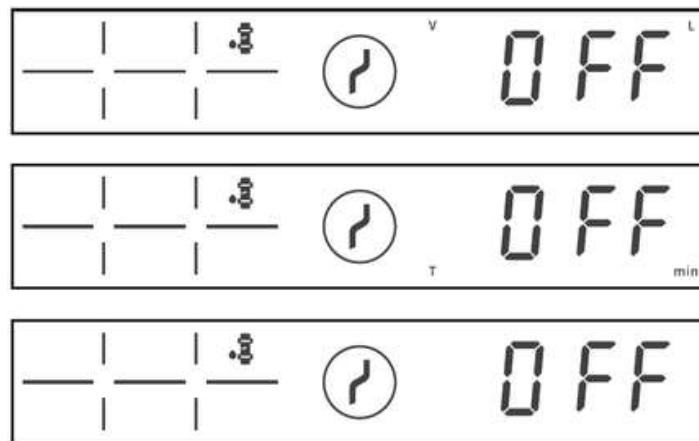
*** WATER TIME (single continuous use time) alarm: "T"+" " indicator quick flashes, "min" indicator lights up, buzzer alarm, valve closed, LED screen shows "OFF", as shown in below picture.

***LEAK ALARM (the sensor probe leak alarm): " " indicator quick flashes, buzzer alarm, valve closed, LED screen shows "OFF", as shown in following picture.







- Manually open or close the inlet electric valve displays: press and hold  +  +  for 3 seconds or continuous press " " 3 times to manually open or close the inlet electric valve. The LED screen shows "OFF", as shown in following picture.









PARAMETER SETTING

All data displayed on the following page is used as an example.



Long press “” 3 seconds to enter into or exit out the parameter setting, and all the set parameter will be saved at the same time. In parameter setting mode, “” key is the parameter selection key, “” key is the transposition key, “” key is number adjustment key (long press to adjust the number quickly).

1. Current time setting: Long press “” key for 3 seconds, and it will show the current water flow (L/min) when water using. Press “” set the current time: 12(hour):00(minute); Hour is set as the unit increasing cycle of 1 hour and minute as the unit increasing cycle of 1 minute (time is set as the 24-hour system). As shown in the following picture. Press “” to go to the next setting interface.



2. Flushing start time setting: 0-02(hour), 0 represents serial number, 0 2 is the default start time, 00-24 is adjustable, set to 1 hour as the unit of increasing cycle, the time is set to 24 hours. As shown in the picture below. Press “” to enter the next setting interface. As shown in the picture below. Press “” to enter the next setting interface.





3. Set the flushing interval time: 1-4 (hours), 1 represents the serial number, 24 hours is the default interval time, 0 0 to 99 hours can be adjusted, and the time is set as an increasing cycle of 1 hour. As shown in the picture below. Press “” to enter the next setting interface. As shown in the picture below. Press “” to enter the next setting interface.





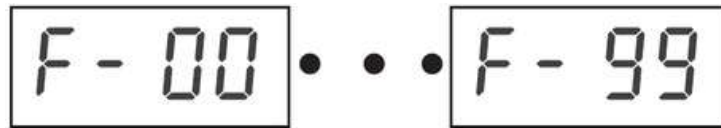

4. Flushing time setting (automatic flushing and manual flushing the same) : F-05(second), F represents the serial number, 5 seconds for the default time, 00-9 seconds adjustable, time set to 1 second for unit increasing cycle, set to 0, long press "  " four three seconds manual open or close flushing valve, as shown in the below picture.

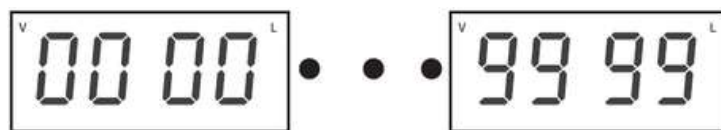

5. Volume (single water use consumption volume) setting: default-180 Liters, "0000-99999" liters can be adjusted, when set with "0", this function is invalid, "V"+"L" indicator lights up at the same time, as shown in the picture below. Press "  " to enter the next setting interface.



6. Water time (single continuous use time) setting: default-45 minutes, "0000-9999" minutes can be adjusted, when set with "0", this function is invalid, "T"+"min" indicator lights up at the same time, as shown in the picture below. Press "  " to enter the next setting interface.

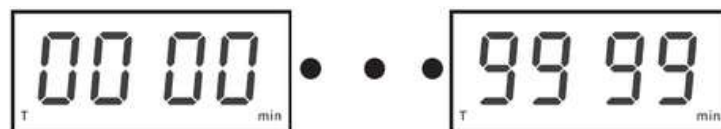

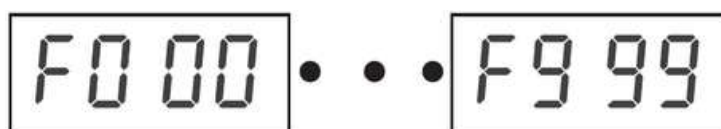

7. Automatic water restore supply time setting: "F015 s" , F represents serial no., 015 is the default time, 000-999s can be adjusted, when set with "0", this function is invalid. When the abnormal situation described in 11,12 above occurs and leads to the valve closing and water supply shutdown, if the faucet is closed within 15s, the water supply will be automatically resumed. If the faucet is not closed within this time, the valve should be closed and the valve should be opened manually. As shown in the picture below. Press "  " to enter the next setting interface.



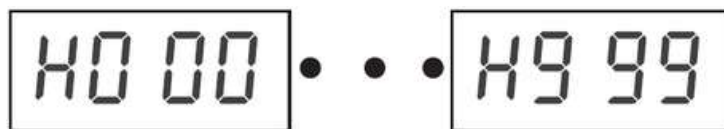

8. Holiday mode (automatic valve closing time without continuous water supply) time setting: "H003 days", H represents serial no., 003 is the default days, 000-999 days can be adjusted, when set with "0", this function is invalid. After the valve is closed beyond the set days, the valve shall be manually opened, as shown in the picture below. Press "  " to enter the next setting interface.



9. Every turn flow setting for flow meter: L-660ml/n, L represents the serial number, 660mL/n is the default value, 000-999ml/n is adjustable. As shown below, press "  " to enter the next setting interface.



10. Valve self-test interval time setting: "P-10" days, P represents serial no., 10 is the default days, the number of days is set as 1 day for the unit increasing cycle, when the number of days reaches the set value, the valve will be automatically switched on and off once to verify whether the valve function is abnormal, (default: 02:00). It is invalid when it sets with "0", as shown in the picture below. Press "  " to enter the next setting interface.

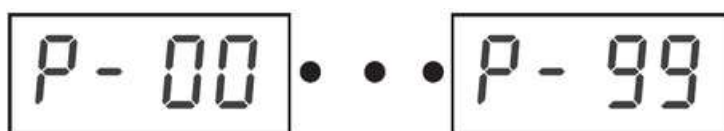

11. Filter service life setting: 800 T, "T" represents unit "Ton", 800 is the default value, 000-999 ton is adjustable. (The hall sensor to obtain the data) "T" indicator lights up at the same time, as shown in below picture, press "  " to enter the next setting interface.





WORKING MODE

There are two mode for the machine: normal working mode and power saving working mode.

1. Function in normal working mode: water production, manual flushing, auto flush, service, low power alarm, remote control, sensor probe detects leak and alarm, volume detects leak and alarm, tim detects leak and alarm, filter service life expired alarm, WIFI connection.
2. Function in power saving mode: cancel the WIFI connection,remote control, sensor probe detects leak and alarm, volume detects leak and alarm, tim detects leak and alarm, filter service life expired alarm.

Double power supply for automatic switching,automatically enter normal working mode when external power supply is supplied, which can realize all set functions: When the external power supply is off, it automatically switches to the battery power supply and starts the power-saving working mode. Only the basic functions are realized and some functions are automatically shielded to save power.

The pairing method between the main device and the remote controller.

Continuously press "MENU" for 5 times, then the "MENU" indicator will flash continuously, press the "OPEN" or "CLOSE" button on the remote controller for pairing; The main device will ring 2 times if it paired successfully. The "MENU"indicator is constant light up to exit pairing. If it is not paired successfully. the device will not ring then reset the main device is needed before pairing again according to the above method.

THE USAGE OF THE SENSOR PROBE

Before use the sensor probe, it has to be paired with the main device for normal using. The device could pair with 1pc remote controller and 7pcs sensor probe; If exceed the paired quantities the device will cover the first pairing unit (the controller or the sensor probe)which means that the first pairing unit is invalid.



1. The pairing method

Continuously press "MENU" key for 5 times, the "MENU" indicator will flash constantly, and then short the positive and negative poles of the sensor probe water short circuit or conductive metal for conduction), the device will ring 2 times if it paired successfully. The "MENU" indicator is constant light up to exit pairing; After pairing succeed, wait till the indicator flashes 60 seconds and run out, then can pair the next sensor probe. Otherwise the pairing will be repeated or failure. Pairing all the sensor probe according to the above method. If it is not paired successfully, the device will not ring, then reset the main device is needed before pairing again according to the above method. As shown in the picture below.



2. Leak indicator alarm mode

When the sensor probe detects the leakage, its positive and negative poles will be short circuited, the leak indicator on the sensor probe will flash and alarm, and send the valve closing instruction to the main device, and device will auto shut off valve; At this time, the valve need to be manually opened.

When the battery voltage is higher than 8V, the leak indicator will flash and alarm for 60 seconds (1 time per second).

When the battery voltage is lower than av, the leak indicator will fast flash and alarm for 60 seconds(2 times per second), at this time, need to replace the battery in time.



NOTE: It will not remind of low power supply when the sensor probe does not detect any leaks or alarm.



3. Use condition

- a. For general users, use with the sensor probe, and place it in the area which is easily leaking; Fast and accurate detects the leaks, and close valve, more safety assurance.
- b. For large water consumption needs user, if the leakage could not be monitored by single continuous water volume and time, adjust this two parameters appropriately, and place the sensor probe in the area which is easily leaking for detection.

4. Pay Attention

- a. Keep out the reach of children to assure normal use when place the sensor probe.
- b. Do not place the sensor probe in an ponding area, in case of false closing valve.
- c. The battery needs to replace every 1-1.5 years.

DAILY FLUSHING

1. In order to maintain a high water purification flow rate of the machine and extend the service life of the filter element, the water purification system has an automatic flushing function. By default, the water purification system flushes once a day (flushing duration is 5 seconds). Users can also define the flushing interval and flushing duration (for details refer to Parameter Settings).
2. Daily automatic flushing is only the process of flushing the water purification system. When the water flow of the water purification system is still less than the nominal value after flush, it should be back flushed to restore water flow. Turn off the inlet valve, turn on the bypass valve and flush port, long press "SET" button for 3 seconds to start manual flush, and repeat the steps of reverse flushing 30 times to use the reverse flow of water to wash away the pollutants in the filter element, as shown below (if you have any questions, please contact the service center to provide back flushing service support).

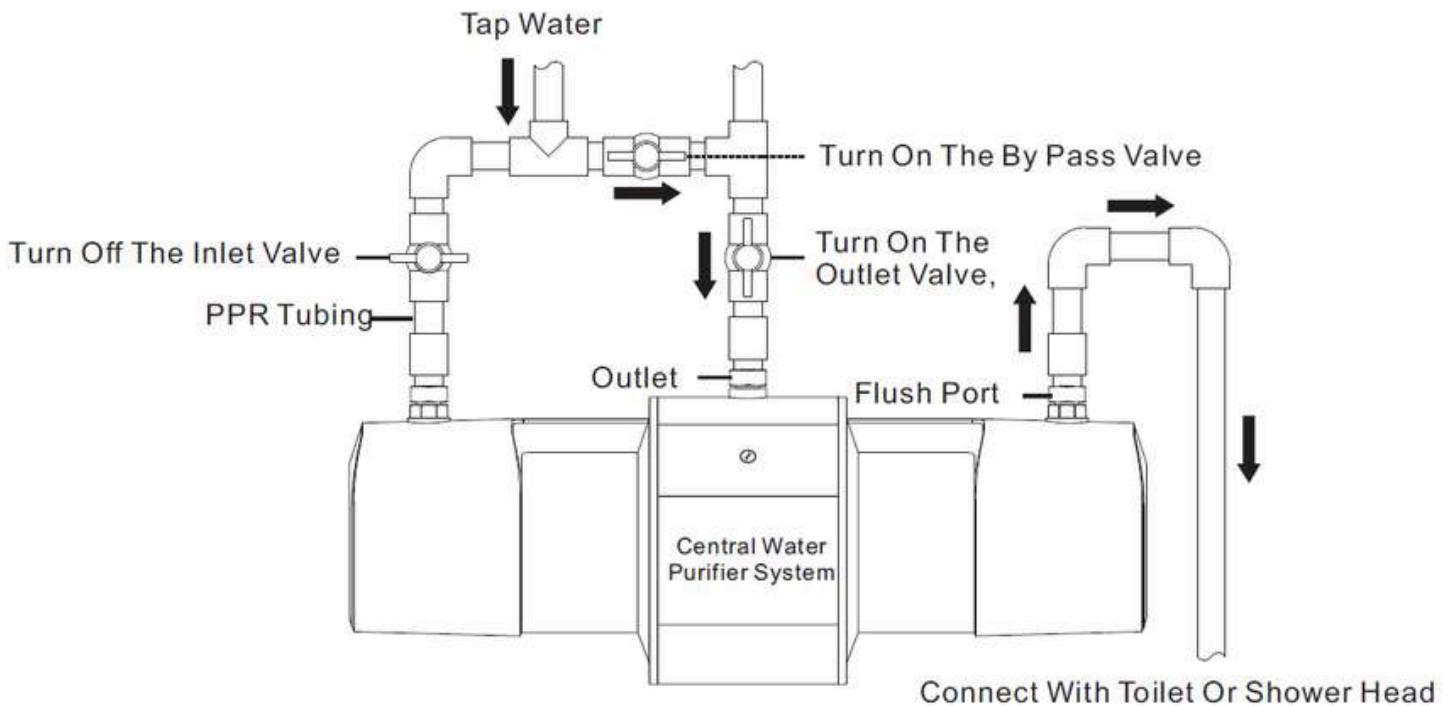

Backwash Operation Diagram

USAGE NOTICE

1. Frequent flushing can effectively prolong the service life of water purification system.
2. The rated total water volume of the water purification system has the relations with the inlet water quality; If the inlet water quality is better, the rated total net water will rise, on the contrary, if the water quality is poor, the rated total net water will decrease, the corresponding filter service life will be shorter.
 - a. With the long-term use of the water purification system, the water flow will gradually decrease, but the water quality is still qualified.
 - b. If the water purification system has not been used for more than three days, please flush it before reusing; It is recommended to manually flush for more than 10 times, then turn on the outlet valve 10 minutes for water production and discharge it.
 - c. The water purification system should always keep the wetting state in the ultra filtration membrane after use. After the ultra filtration membrane filter element dries, the water production will sharply decrease and cannot be recovered.



- d. When going out for a long time (more than 1 day), make sure that the water inlet valve is turned off, so that the water purification system is in an unconfined state, which can prolong the service life of the water purification system and prevent unnecessary risk loss.
- e. Replacement of filter cartridge should be carried out by local retailer or under the guidance of local sale service professionals.
- f. When the water purification system fails, please immediately turn off the tap water inlet valve and turn off the outlet valve. Do not disassemble the water by oneself.
- g. Please call the customer service if find anything unusual or unknown in the process of using this water purification system.

STORAGE NOTICE

1. Store in ventilated and cool place.
2. It can be sealed for one year before the first use. After one year, it should be re-sealed for sterilization. Please consult the customer service department for details.

FILTER ELEMENT REPLACEMENT

Under the condition of normal water production of the filter element, the lifespan of the filter element is monitored by the flow meter. When the water production of the filter element reaches the rated total net water volume, the intelligent control system will automatically alarm and remind the replacement of the filter element.

In some users rarely use the water purification system, so the filter element in a few years or even longer will not alarm, then the filter element has not met the requirements of water production, so we add a filter expiration alarm system.

When the service life of the filter element expires, the display screen will automatically light up, and the LED screen will display "E0" and alarm, reminding to replace the filter element. At this time, the user should replace the filter element in time. As shown in the picture below.



METHOD OF REPLACEMENT

The service life of ultra filtration membrane filter element is generally more than 3 years in the case of influent municipal tap water. Due to the differences in water quality in different area, If the water flow gradually decreases in the process of using the system and still cannot meet the requirements after repeated flushing and back flushing, it is necessary to replace the ultra filtration membrane filter elements.

1. Turn off the inlet valve, take down the water purifier from the installation position.
2. Disassemble the bottom base.
3. Disassemble the cover, display screen, middle bottom base.
4. Disassemble the housing, take out the expired filter element and replace it.
5. After replace a new one filter, need to reset the filter element on the display screen, long press: "  " for 3 seconds till the "E0" alarm free. As shown in bellow picture.



NOTE: After replacing the filter element, be sure to check whether there is water leakage or see page at each connector.

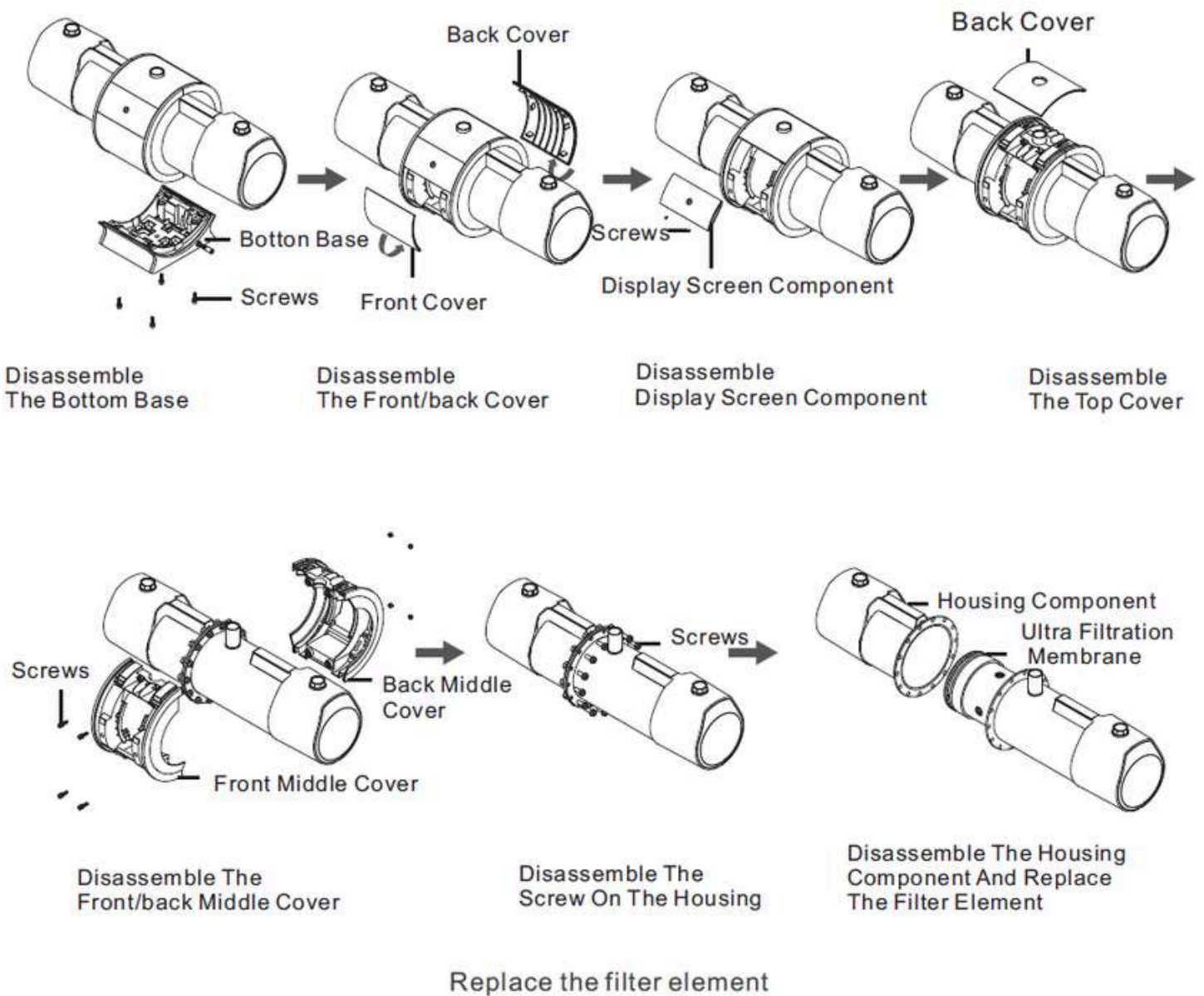

Forced reset unexpired filter element lifespan:

If the service life of filter element is not expired and the service life of filter element needs to be forcibly reset, long press "  " for 10 seconds to forcibly reset the service life of filter element is not expired.



ELECTRIC VALVE MAINTENANCE OR REPLACEMENT

When the electric valve fails and needs to be repaired or replaced, the disassembly method is as shown in the picture below:

1. Disassemble the side cover.
2. Remove the fixing bracket.
3. Push the side top cover and remove the screws and the side shell.
4. Disassemble the electric valve for maintenance or replacement.

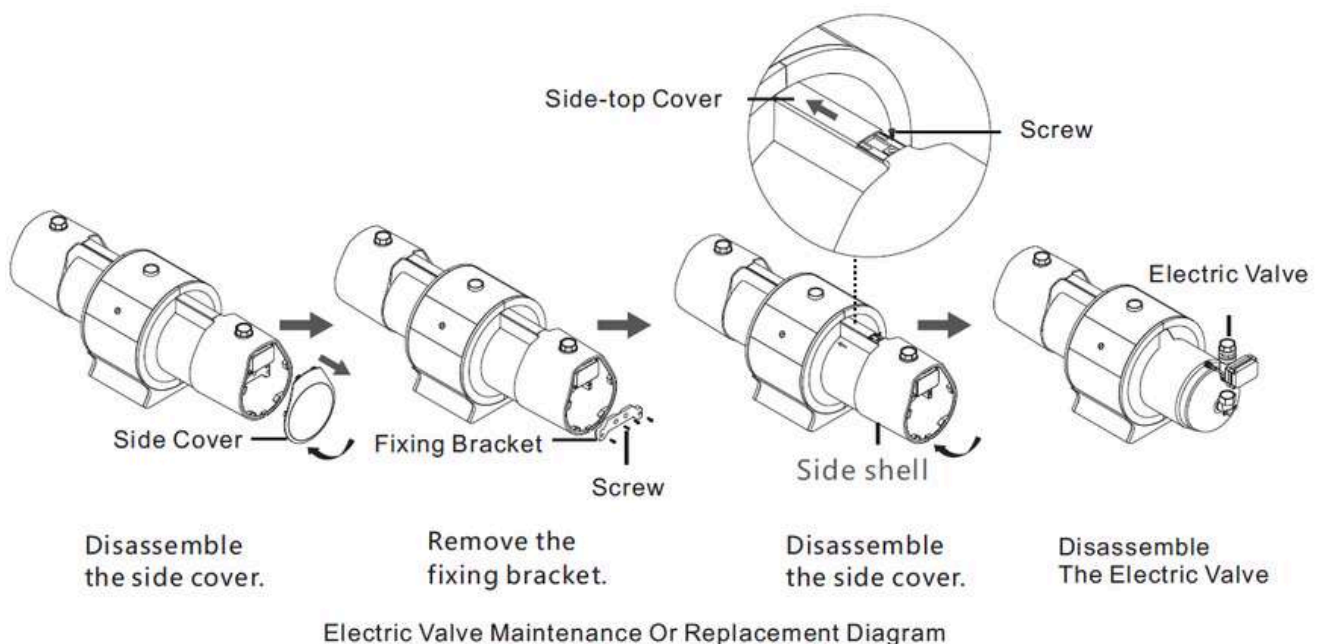

THE BATTERY REPLACEMENT

The host cell replacement

Host cell for rechargeable batteries, when the battery life has expired, or the bulge, and so on and so forth have affect the normal use, the need to replace the battery. Replace the battery as shown in the figure below:

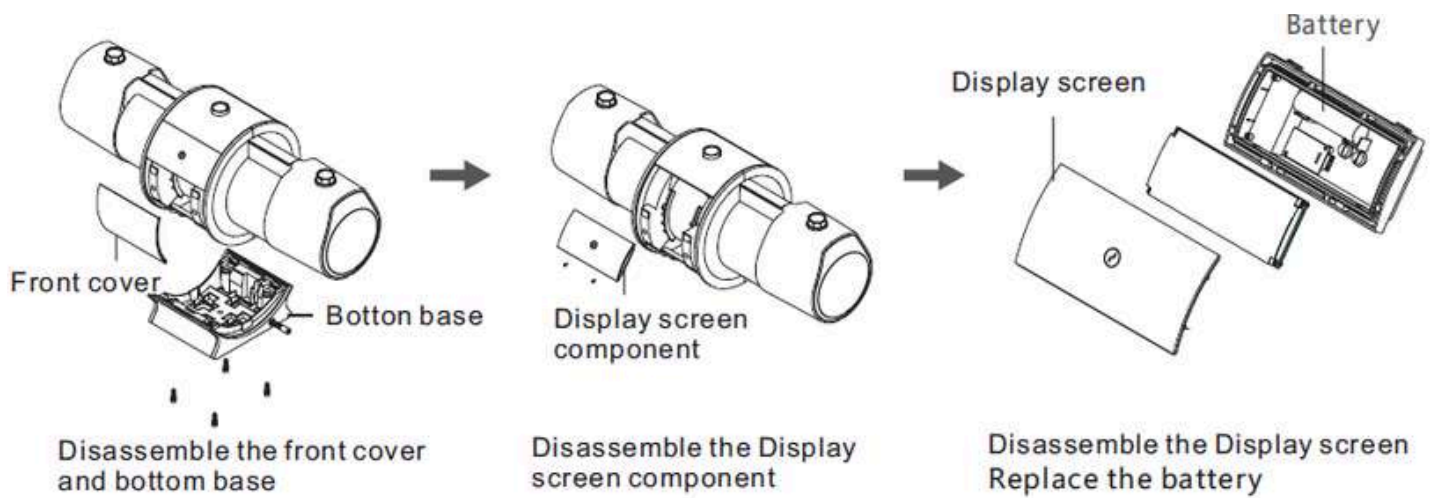

Sensor probe battery replacement

The battery in the sensor probe is non-rechargeable; It is recommended to replace the battery every 1-1.5 years.

Battery specification: 23A 12V. After replacing the battery, you do not need to re-pair it. You can use it directly.

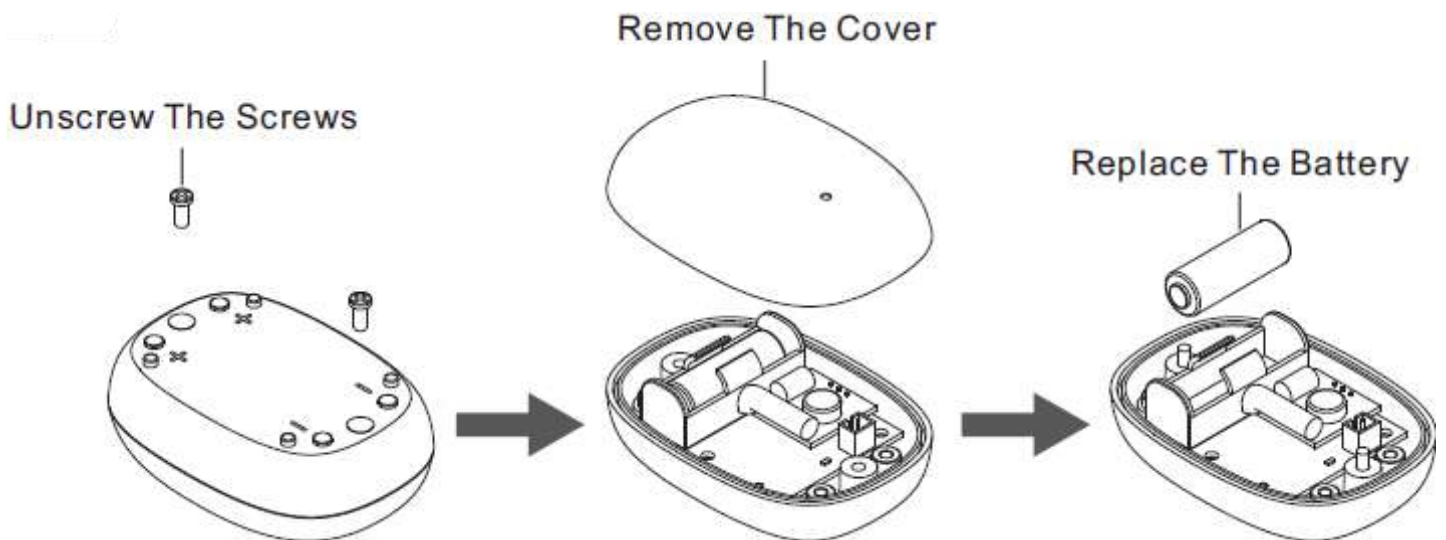



KEY FUNCTION DESCRIPTION

Malfunction	Troubleshooting	Handling
Display screen do not display	Power or connector connection failure	Reconnect the power line
	Display damage	Replace a new display
The pipeline of the water purifier system leakage	The sealing ring for electric valve is damaged or twisted or aged	Replace a new sealing ring
Auto flush when using water	Current time set wrong	Reset the current time
There is some off odor in purified water	The protective liquid remains when first use	Please flush the system according the first use requirement
	The system hasn't been using for a long time	Turn on the outlet or flush valve for flushing
	The smell of tap water is too bad	Add an activated carbon filter cartridge
The purified water flow decrease	Bad quality of the inlet water	Adopt pressurization measures
	The inlet pressure or flow is too low	Add a pre filter system.
	The inlet temperature is to low	It is normal phenomenon.
E0	Filter element expired	Long press"RESET" more than 3 seconds to reset
E1	Electric valve close failure	Replace a new motor control panel or reduction motor
E2	Electric valve open failure	Replace a new motor control panel or reduction motor



PACKING LIST

No.	Parts Name
1	Main Device
2	Power Adapter
3	Leak Sensor Probe (optional)
4	Remote Control (optional)
5	Manual
6	Stainless Steel Mounting Plage
7	86n Fitting (optional)
8	1" Flat Gasket
9	Self Taping Screws Kits

ULTRA FILTRATION MEMBRANE TECHNOLOGY

Ultra filtration membrane technology is a kind of ultra filtration membrane and the membrane pore size related to the size of the screening process, driven by the pressure difference on both sides of the membrane, ultra filtration membrane as the filter medium, under certain pressure, when the original fluid flow through the membrane surface, ultra filtration membrane surface with many tiny pores allow only water and small molecules through and become through the liquid, and concentrate in the volume is greater than the membrane surface micro aperture that substance is trapped At the inlet side of the membrane, it becomes concentrated liquid, thus achieving the purpose of purification, separation and concentration of the original liquid. Ultra filtration membrane separation technology, as one of the 21st century high and new technologies, has become a standard of separation process with its obvious characteristics of normal temperature, low pressure operation, no phase change and low energy consumption. It has been widely used in Europe and The United States and other developed countries and regions, and has become the mainstream technology of deep purification of drinking water. Ultra filtration membrane technology has replaced the traditional separation technology to a large extent to save energy, reduce consumption and improve separation quality.



FILTRATION PRINCIPLE OF ULTRAFILTRATION MEMBRANE

In the presence of pressure difference of the ultra filtration membrane on the both sides, when the water flow through the membrane surface, ultra filtration membrane surface with many tiny pores (per meter long ultra filtration membrane silk pipe distribution about 6 billion 0.01 micron pores) allow only water molecules and small molecules by beneficial minerals and trace elements, and the volume is greater than the pore diameter of materials (including sediment, rust, colloid, suspended matter, and pathogenic bacteria and other harmful substances) are intercepted, so as to achieve the purification of tap water. (As show in pic. 13)

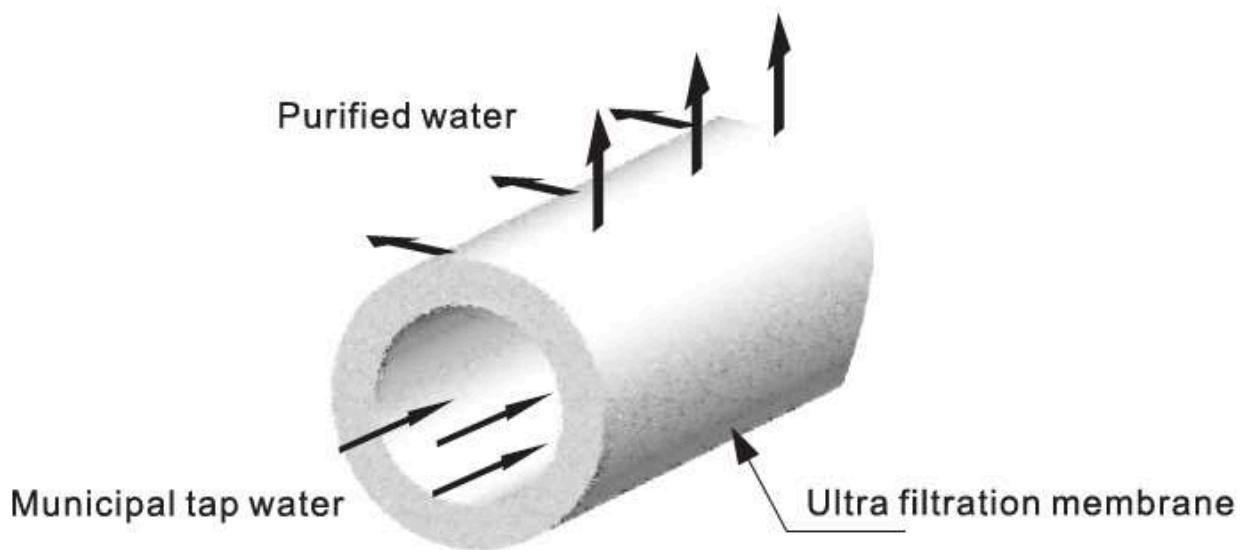

Pic. 13 Filtration Principle of ultra filtration membrane



PRODUCT DIMENSION

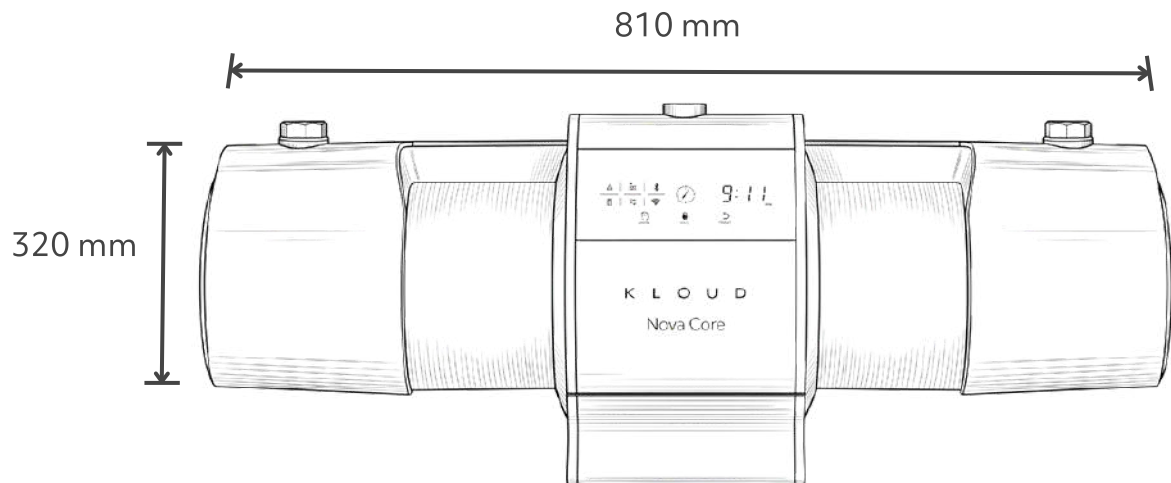

K L O U D

Nova Core



KLOUD™ | DESIGNED IN UAE

www.kloudfilter.com

Water, The Way It *Should* Be

